

YARCK Locks reserves the right to change the design and specifications that time without notice, all the information has been carefully checked, for accuracy, and if there is any typographical errors or omissions or in the production of the errors that may arise, the company do not bear the consequences resulting, the printing process may result in the product information with a slight difference in kind, select the product to prevail in kind.

YARCK 13819770896

**yarck**<sup>®</sup>  
HEA VY DUTY



**yarck**<sup>®</sup>  
HEA VY DUTY

CATALOG  
Door Hardware  
2022

Convenient



DOOR LOCK SERIES

SMART LOCK

MODEL NO: Q7-2 BLK



Technical Parameter:

- Power Supply : 5V (Rechargeable battery )
- Typical Quiescent: < 55 mA (Battery charge one time can use 5 month)
- Working Current:<250 mA(strong driving capability)
- No of Fingerprint: ≥100
- No of Cards: ≥100 (2 pcs free)
- No of password: ≥100
- Manual key: 2
- Resolution: 500 DPI
- Error Identification rate : ≅0.0004%
- Operating Temperature : -30 ℃-60 ℃
- Relative Humidity: -20%-93%

LOCK BODY SIZE

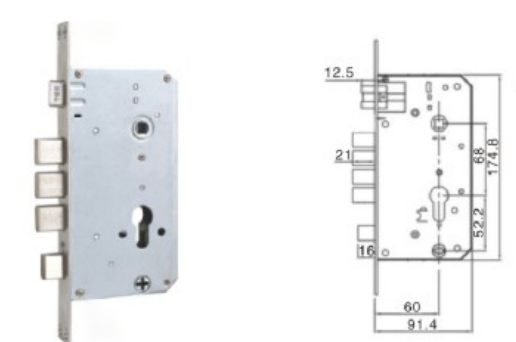

MODEL NO: 68003

SMART LOCK STANDARD SIZE ( EASY TO DIY REPLACE )

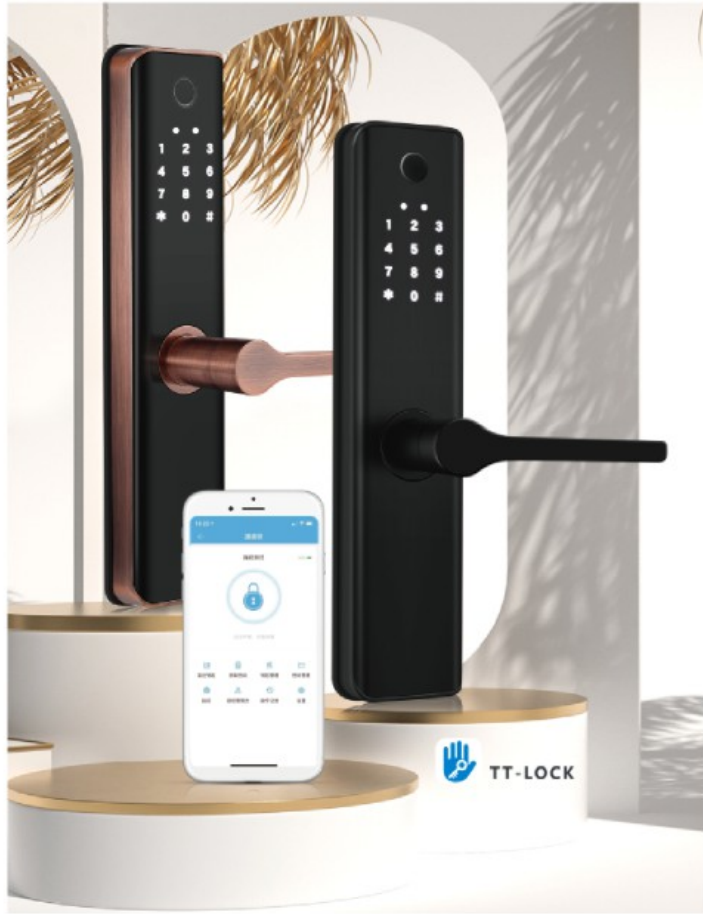

MODEL NO: F76

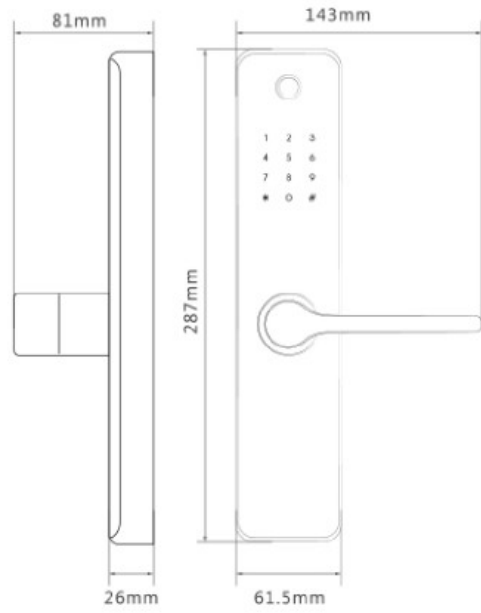

- BLUETOOTH APP  
TT LOCK
- FINGERPRINT
- CARD
- \*\*\*SIS\*\*\*  
PASSWORD
- KEY

Technical Parameter:

Power Supply : 4.5-6V ( 4 PCS AA BATTERY )  
 Typical Quiescent: < 55 mA  
 (Battery can use 5 month)  
 Working Current: < 250 Ma  
 (strong driving capability)  
 No of Fingerprint: ≥ 100  
 No of Cards: ≥ 100 ( 2 pcs free)  
 No of password: ≥ 100  
 Mutual key: 2  
 Resolution: 500 DPI  
 Error Identification rate : ≤ 0.0004%  
 Operating Temperature : -30 °C - 60 °C  
 Relative Humidity: -20% - 93%

STANDARD ITALY AND GERMANY  
MORTISE LOCK SIZE ( EASY TO DIY REPLACE )

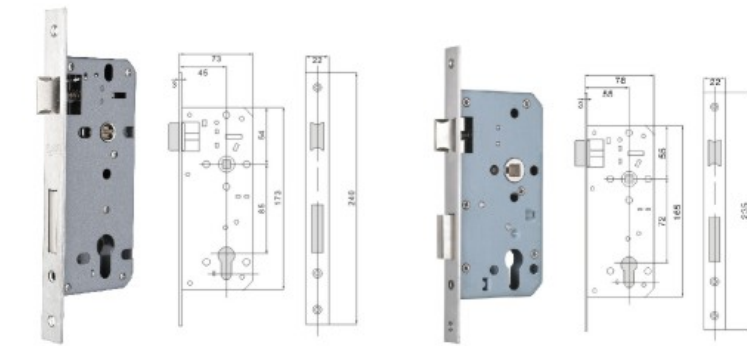

Model No: 8545 SS

Model No: 7255 SS

SMART ON ROSE LOCK  
STANDARD ITALY AND GEMERNY SIZE (EASY TO DIY REPLACE)

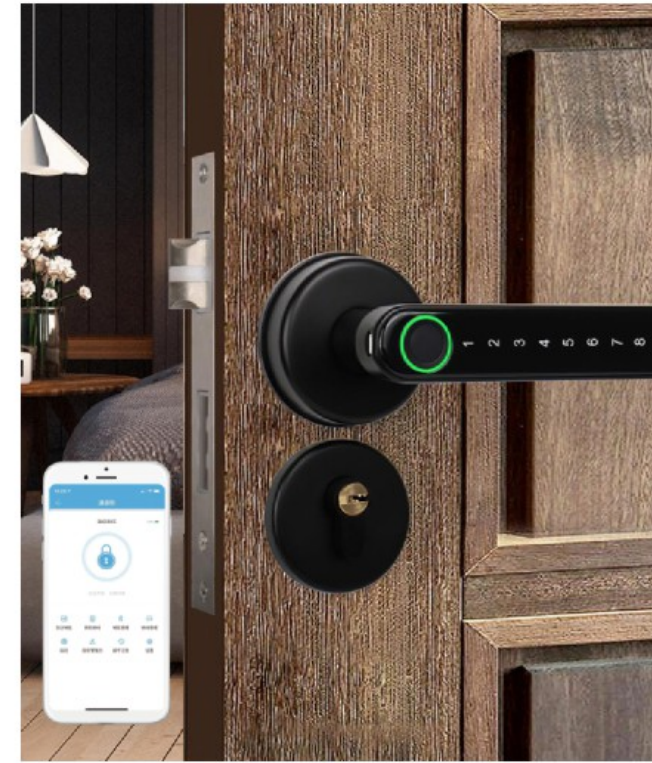

MODEL NO: F75

- BLUETOOTH APP  
TT LOCK
- FINGERPRINT
- CARD
- \*\*\*SIS\*\*\*  
PASSWORD
- KEY

DOOR LOCK SERIES



Fingerprint Collection Semiconductor	Unlock Delay 5S	Low Voltage Alarm ≤ 4.8VDC
Working Voltage 6VDC 4 Pcs AAA Batteries	Fingerprint Capacity 120 Sets	Password Capacity 120 Sets



WIFI/ BLUETOOTH

GATE WAY



Gateway G2

- Remote view Fingerprint unlock / Password unlock / Card unlock records
- Remote unlock by connected gateway
- Remote add/delete user Password/card/fingerprint management

Model: G2  
 Dimensions: 70\*70\*26 MM  
 Network: WiFi 2.4G  
 IEEE Standard: 802.11 b/g/n  
 Power Interface: Type-C USB  
 Power Input: DC 5V/500mA

The gateway can be paired within 60 seconds when it is powered on.



Technical Parameter:

Power Supply : 5V (Rechargeable battery )  
 Typical Quiescent: < 55 mA (Battery charge one time can use 5 month)  
 Working Current:<250 mA(strong driving capability)  
 No of Fingerprint: ≥100  
 No of Cards:≥100 (2 pcs free)  
 No of password: ≥100  
 Manual key: 2  
 Resolution: 500 DPI  
 Error Identification rate : ≅0.0004%  
 Operating Temperature : -30 ℃-60 ℃  
 Relative Humidity: -20%-93%

LOCK BODY SIZE

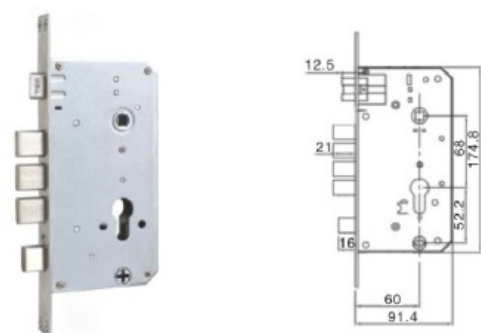

MODEL NO: 68003

MODEL NO: 9850



POWER SUPPLY HOLE



MODEL NO: Q9



SMART CYLINDER (EASY REPLACEMENT AND INSTALLATION)



Original

Replace



F71-70MM



F71-80MM



**DOOR LOCK SERIES**



9803L-03 AD

Total depth 89mm

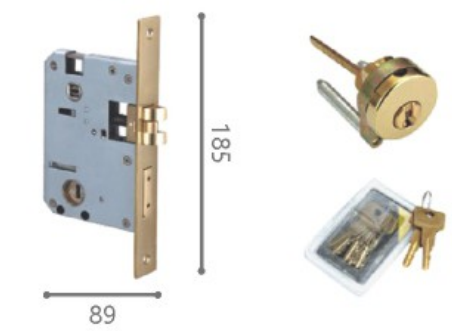

9803 LOCKBODY AND CYLINDER



SP-KE21

KE21



9809L-06 SN/CP



9809M-06 SN/CP



Model No: 9810M-07 DAB  
(COLOR AVAILABLE: PVD/BLACK)



LUXURY MAIN DOOR LOCK (ITALY STANDARD)

LUXURY MAIN DOOR LOCK (ITALY STANDARD)

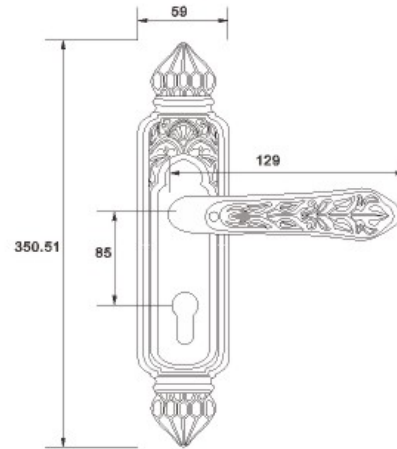

Model No: DD03-AA198 MAE  
ZINC PLATE+ZINC HANDLE

Model No: DD03-AA198 MAB  
ZINC PLATE+ZINC HANDLE

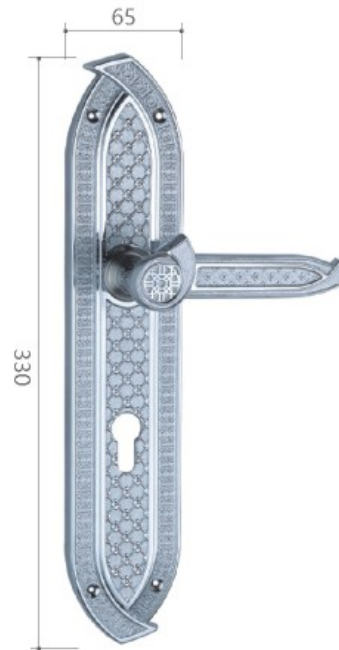

Model No: DD29-AA30 CP  
ZINC PLATE+ZINC HANDLE

Model No: DD29-AA30 MAE  
ZINC PLATE+ZINC HANDLE

Model No: DD29-AA30 GP  
ZINC PLATE+ZINC HANDLE

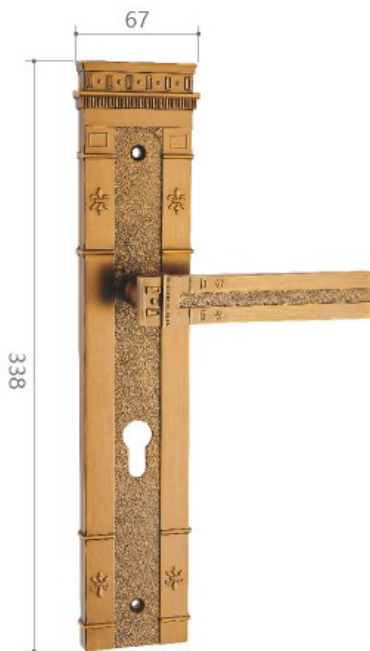

Model No: DD05-AA199 MAE  
ZINC PLATE+ZINC HANDLE

Model No: DD05-AA199 MAC  
ZINC PLATE+ZINC HANDLE

Model No: DD05-AA199 MAB  
ZINC PLATE+ZINC HANDLE

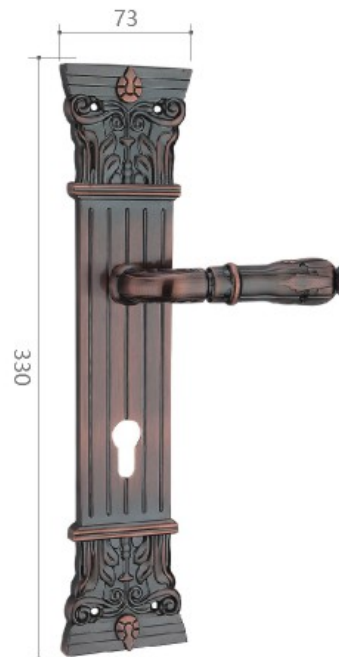

Model No: DD12-AA17 AC  
ZINC PLATE+ZINC HANDLE

Model No: DD12-AA17 MAE  
ZINC PLATE+ZINC HANDLE

Model No: DD12-AA17 GP  
ZINC PLATE+ZINC HANDLE



AA615-AA320 SN/RGP FULL ZINC MATERIAL  
 AA615-AA320 MSN/CP FULL ZINC MATERIAL  
 AA615-AA709 MSN/CP FULL ZINC MATERIAL  
 AA615-AA709 SN/RGP FULL ZINC MATERIAL



AA314-AA315 MAC FULL ZINC MATERIAL  
 AA314-AA315 MAB BLACK AVAILABLE  
 AA314-AA315 GP FULL ZINC MATERIAL  
 AA314-AA315 MAE FULL ZINC MATERIAL



AA315-AA323 MSN FULL ZINC MATERIAL  
 AA315-AA323 MAB FULL ZINC MATERIAL  
 AA315-AA323 MSB FULL ZINC MATERIAL  
 AA615-AA707 BLK FULL ZINC MATERIAL



AA615-AA330 MSN FULL ZINC MATERIAL  
 AA615-AA330 MAC FULL ZINC MATERIAL  
 AA615-AA330 MAE FULL ZINC MATERIAL  
 AA615-AA330 MAB FULL ZINC MATERIAL

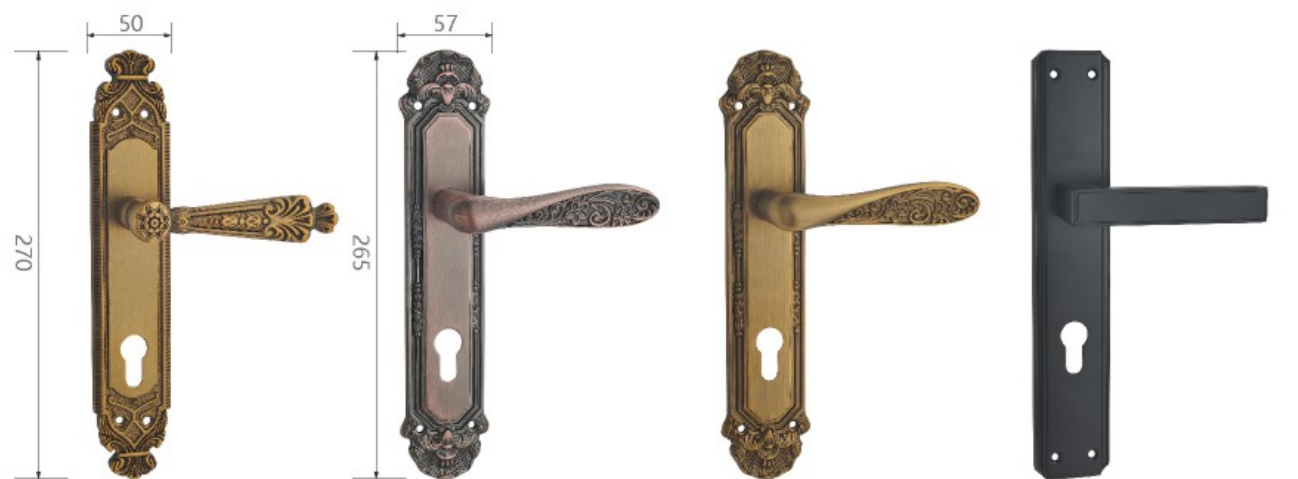

AA501-AA502 MAE FULL ZINC MATERIAL  
 AA325-AA326 MAC FULL ZINC MATERIAL  
 AA325-AA326 MAE FULL ZINC MATERIAL  
 AA615-AA403 BLK ZINC PLATE+ALU HANDLE

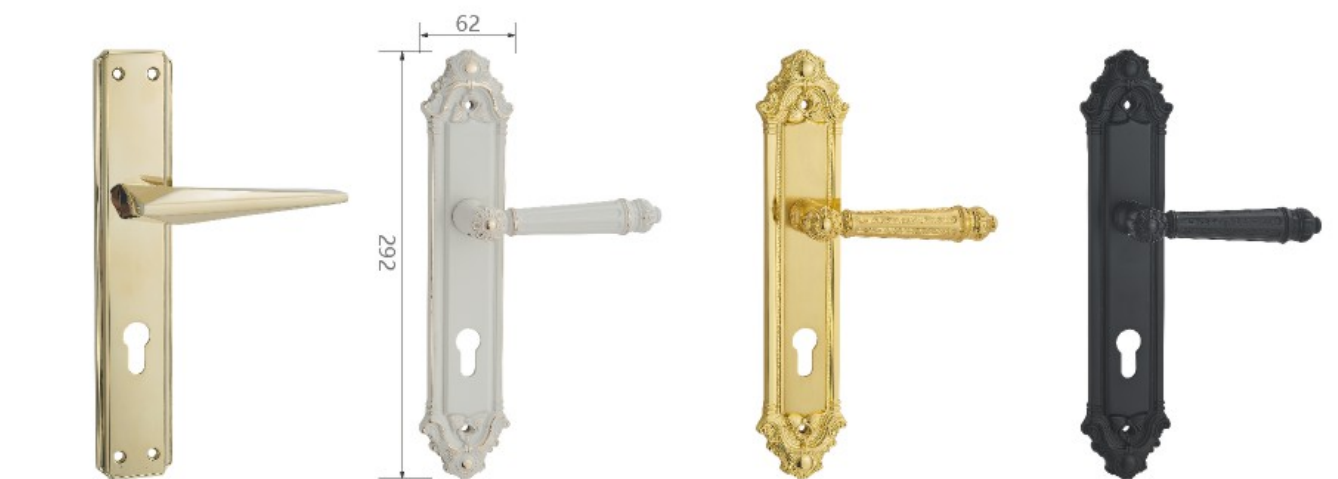

AA615-AA330 PVD FULL ZINC MATERIAL  
 AA310-AA311 WGP FULL ZINC MATERIAL  
 AA310-AA311 SG/GP FULL ZINC MATERIAL  
 AA310-AA311 BLK FULL ZINC MATERIAL





AA301-AA302 MAB  
FULL ZINC MATERIAL



AA301-AA302 MAC  
FULL ZINC MATERIAL



AA301-AA302 MAE  
FULL ZINC MATERIAL



AA503-AA504 MAE  
FULL ZINC MATERIAL



AA213-AA214 WGP  
FULL ZINC MATERIAL



AA213-AA214 GP  
FULL ZINC MATERIAL



AA213-AA214 MAC  
FULL ZINC MATERIAL



AA213-AA214 MAE  
FULL ZINC MATERIAL



AA41-AA19 MAE  
FULL ZINC MATERIAL



AA41-AA19 MAC  
FULL ZINC MATERIAL

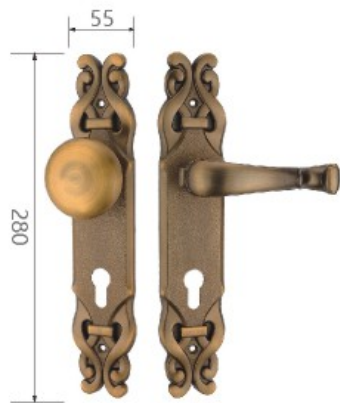

AA118/171 MAE  
FULL ZINC MATERIAL



AA102/903 SN/CP  
AVAILABLE GP COLOR



AA102-AA23 SN/CP



AA102-AA23 SN/GP



AA102-AA23 GP



AA102-AA23 MAC



AA307-AA309 SN/CP  
FULL ZINC MATERIAL



Z614-AA313 SN/CP



AA201-AA202 SN/CP



AA104-AA24 SN/CP

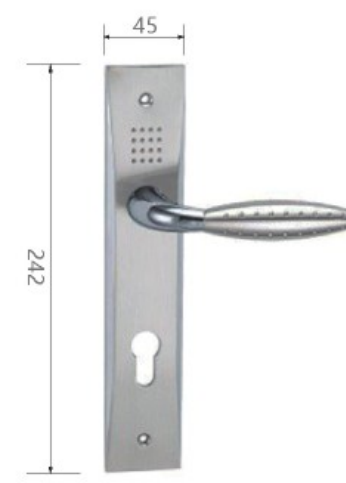

AA102-AA65 SN/CP

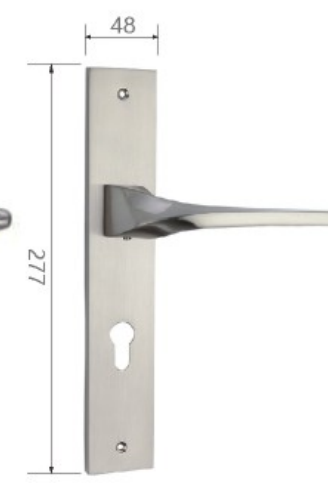

AA4-AA46 SN/CP

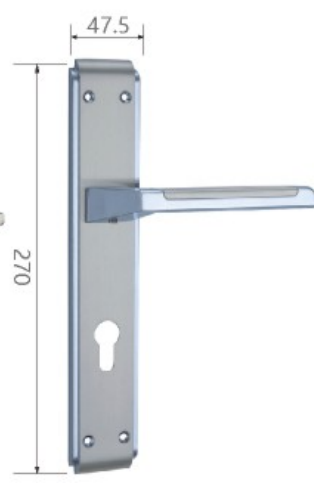

Z614-AA43 SN/CP



AA616-AA324 SN/CP  
FULL ZINC MATERIAL



AA617-AA406 BLACK/PB    AA617-AA406 MAB/PB    AA617-AA406 MAE/PB    AA617-AA406 MSN/CP

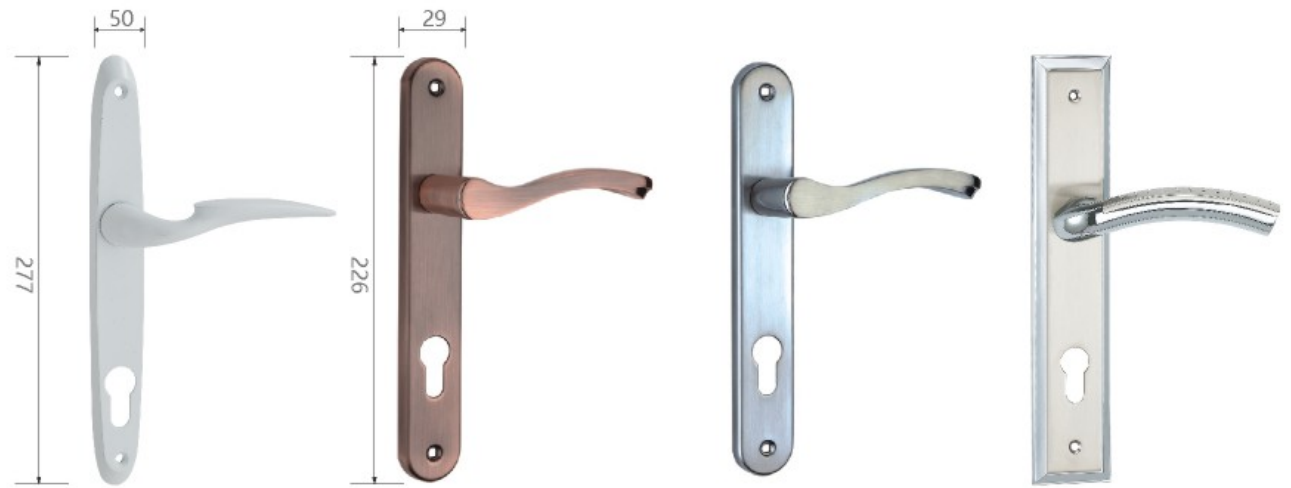

S05-168 W    S06-AA169 AC    S06-AA169 SN/CP    AA106-AA23 SN/CP  
 FULL ZINC AVAILABLE BLACK    MAB COLOR AVAILABLE    FULL ZINC MATERIAL



T85102-LAA23 SN/CP  
 ALUMINIUM HANDLE +  
 IRON PLATE



T85102-9611 SG/GP  
 ALUMINIUM HANDLE +  
 IRON PLATE



T85102-9611 MAB  
 ALUMINIUM HANDLE +  
 IRON PLATE



T85108-LAA20 SN/CP  
 ALUMINIUM HANDLE +  
 IRON PLATE



T85109-LAA21 SN/CP  
 ALUMINIUM HANDLE +  
 IRON PLATE



T617-L52 SN/CP  
 ALUMINIUM HANDLE +  
 IRON PLATE



Z614-L218 SN/RGP  
 FULL ZINC MATERIAL



T58103-LAA23 SN/CP  
 ALUMINIUM HANDLE +  
 IRON PLATE



T5827-LAA132 SN/CP  
 ALUMINIUM HANDLE +  
 IRON PLATE





NEW ARRIVAL

DOOR LOCK SERIES



R11-AA705 MAB



R11-AA705 BLK



R11-AA705 MSN



R11-AA704 BLK



R11-AA704 MSN



R11-AA704 PVD





**R11-AA702 MSN**  
Material:full zinc material



**R11-AA702 BLK**  
Material:full zinc material



**R11-AA707 MSN**  
Material:full zinc material



**Z10-AA320 MSN/CP**  
FULL ZINC MATERIAL



**Z10-AA320 SN/RGP**  
FULL ZINC MATERIAL



**Z10-AA320 CP/BLACK**  
FULL ZINC MATERIAL



**R11-AA715 PVD**  
Material:full zinc material



**R11-AA715 MSN**  
Material:full zinc material



**R11-AA707 BLK**  
Material:full zinc material



**Z10-AA49 MSN/CP**  
FULL ZINC MATERIAL



**Z10-AA49 MSN/MBN**  
FULL ZINC MATERIAL



**Z10-AA49 MSN/RGP**  
FULL ZINC MATERIAL



**R11-AA708 MSN**  
Material:full zinc material



**R11-AA701 BLK**  
Material:full zinc material



**R01-AA714 MSN**  
Material:full zinc material



**R11-AA709 SN/RGP**  
FULL ZINC MATERIAL



**R11-AA709 MSN/MBN**  
FULL ZINC MATERIAL



**Z10-AA44 MSN/MBN**  
FULL ZINC MATERIAL



**Z10-AA319 MSN/CP**  
CP/BLACK AVAILABLE

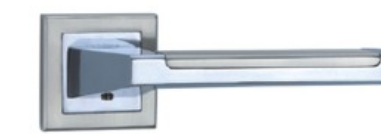

**Z07-AA43 SN/CP**  
FULL ZINC MATERIAL



**R11-AA321 MSC**  
(BLACK AVAILABLE)



**Z10-AA710 GP**  
FULL ZINC MATERIAL



**Z10-AA323 MSN**  
FULL ZINC MATERIAL



**Z10-AA323 MAB**  
FULL ZINC MATERIAL



**Z01-AA23 SN/CP**  
Material:full zinc material



**Z01-AA23 SN/GP**  
Material:full zinc material



**Z01-AA23 GP**  
Material:full zinc material



**Z10-AA710 MSN/MBN**  
Material:full zinc material



**Z10-AA330 MSN**  
Material:full zinc material



**Z10-AA330 MAB**  
Material:full zinc material



**Z01-AA23 MAB**  
Material:full zinc material

(MAB COLOR AVAILABLE)



**CK901-AA212 SN/CP**  
Material:full zinc material



**CK901-AA212 SG/GP**  
Material:full zinc material



**R15-AA315 MCF**  
FULL ZINC MATERIAL



**R01-AA318 BLACK**  
FULL ZINC MATERIAL



**R01-AA318 MSC**  
FULL ZINC MATERIAL



**CK901-AA325 SN/CP**  
Material:full zinc material



**CK901-AA116 SN/CP**  
Material:full zinc material



**CK901-AA118 SN/CP**  
Material:full zinc material



**CK901-AA302 MAB**  
Material:full zinc material



**R16-AA326 PVD**  
Material:full zinc material



**R16-AA326 MAB**  
Material:full zinc material



**CK901-AA324 SN/CP**  
FULL ZINC MATERIAL



**CK901-AA81 SN/CP**  
Material:full zinc material



**CK901-AA80 SN/CP**  
Material:full zinc material



**CK901-AA115 SN**  
Material:full zinc material



**CK901-Z58 SN**  
Material:full zinc material



**CK901-AA313 SN/CP**  
Material:full zinc material



**Q03-949 MAB**  
Material: zinc cover + aluminium handle



**Q03-9212 SN/CP**  
Material: zinc cover + aluminium handle



**Q03-9611 SN/CP**  
Material: zinc cover + aluminium handle



**Z09-AA214 MAC**  
Material:zinc alloy



**Z08-AA949 MSN**  
Material:full zinc material



**Z08-AA949 BLK**  
Material:full zinc material



**Q03-9216 MSN**  
Material: zinc cover + aluminium handle



**Q03-9325 SN/CP**  
Material: zinc cover + aluminium handle



**Q03-9313 SN/CP**  
Material: zinc cover + aluminium handle



**Z08-AA403 MSN**  
Material:full zinc material



**Z08-AA403 GP**  
Material:full zinc material



**Z08-AA403 MAB**  
Material:full zinc material



**Z08-AA403 BLK**  
Material:full zinc material



**Z08-AA404 MSN/CP**  
Material:full zinc material



**Z08-AA405 MSN/CP**  
Material:full zinc material





**S02-847 SS**  
Material: Original stainless steel  
(Rale:304)



**S02-809 SS**  
Material: Original stainless steel  
(Rale:304)



**S07-810 SS**  
Material: Original stainless steel  
(Rale:304)



**C03-9106 SS**  
Material : SS RATE 201



**C03-9102 SS**  
Material : SS RATE 201



**C03-9103 SS**  
Material : SS RATE 201



**S02-105 SB/SP**  
Material: Original stainless steel  
(Rale:304)



**S02-103 SS**  
Material: Original stainless steel  
(Rale:304)



**S02-101 SS**  
Material: Original stainless steel  
(Rale:304)



**C03-9105 SS**  
Material : SS RATE 201



**C03-9109 SS**  
Material : SS RATE 201



**C03-9110 SS**  
Material : SS RATE 201



**S03-102 SS**  
Material: Original stainless steel  
(Rale:304)



**C03-958 PVD**  
Material: Original stainless steel



**C03-958 BLK**  
Material: Original stainless steel



**C03-958 SS**  
Material : SS RATE 201



**C03-9106 PVD**  
Material: Original stainless steel



**C03-9106 BLK**  
Material: Original stainless steel





A97 PVD



A98 PVD



19\*225 PVD

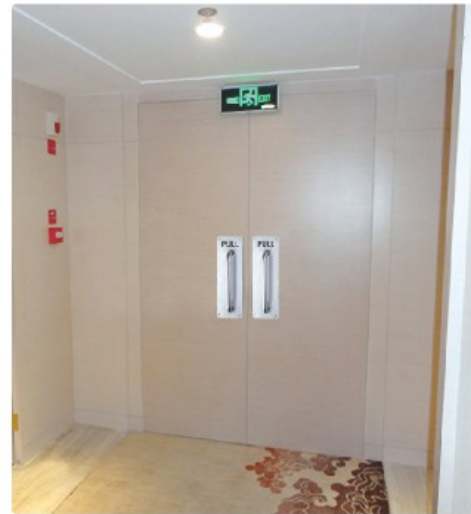

A97 SS



A98 SS



19\*225 SS



19\*150 SS



SQ72 SS

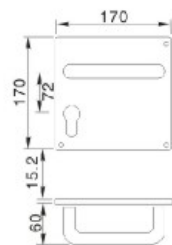

SQ85 SS

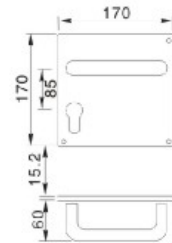

INTELLIGENT HOTEL LOCK SYSTEM

DOOR LOCK SERIES

Internal Structure and Characteristics

1. Quality Test: Successfully pass 200,000 open/close test (TESE IN OUR FACTORY)
2. Warranty : 2 Years
3. Card Type: Temic T5557



MODEL NO: YK2803 GP



MODEL NO: YK2803 SS



MODEL NO: YK2903 SS



BODY SIZE

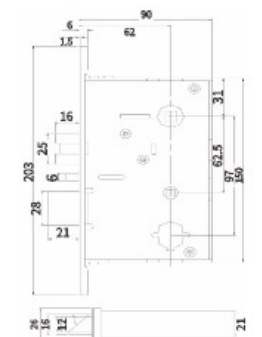

Hotel Lock Management System

Hotel Intelligent Door Lock System is a set of software and hardware integrated system, which is composed of the following parts :

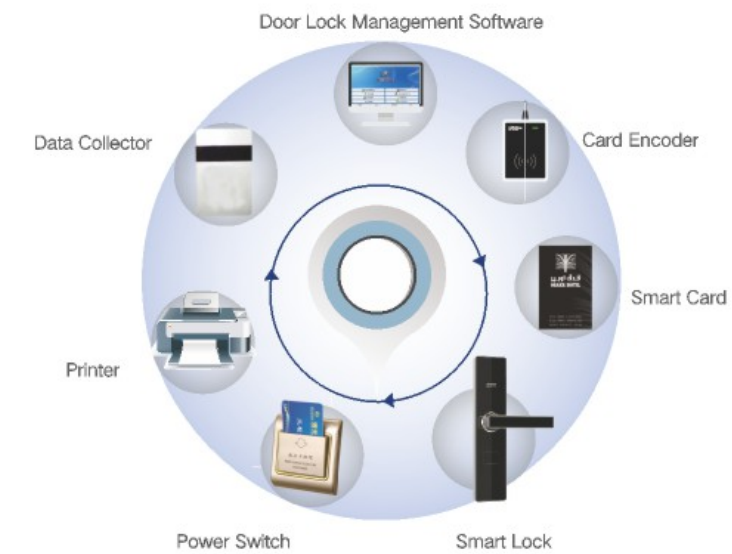

Software System

Support Windows 3.1 and above systems.

Management software

Manage the system, including setting the door lock function, limiting the permissions of the cardholder, reading the unlocking record, adjusting the clock inside the lock etc.

Card Encoder

Connect with the computer's USB interface to operate the card.

Smart Card

Divided into normal card and management card.

Normal Card Functions

Room card, cleaning card, floor card, building card, master card.

Management Card Functions

Room No. setting card, date/time setting card, record card, area card.

Card Type

Temic T5557 Card / Mifare-1 Card

Remarks : Every Part Needs to Purchase Individually.





Electric lock H508



Magnetic lock M280



Electric Glass Door lock



Electric Strike Lock



Z Holder



U Holder

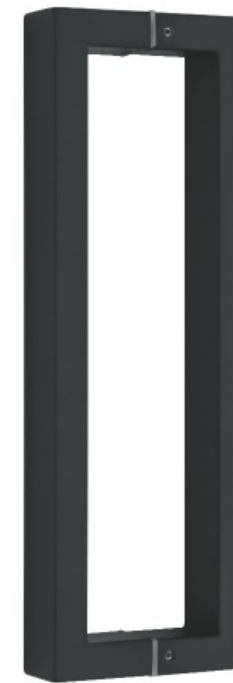

COLOR: BLK



COLOR: SSS



COLOR: MAT GOLD

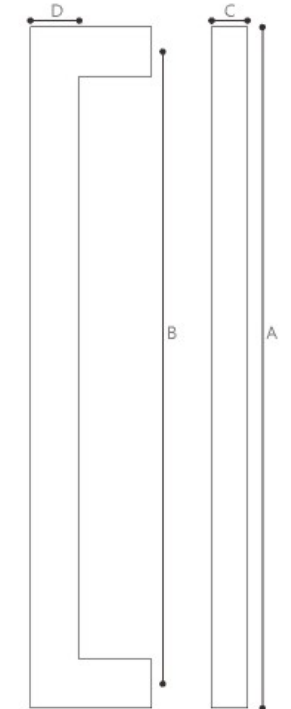

MAT GOLD



Access Control K05



Access Control S601 EM  
(water proof)



Power Supply P06



SS PUSH BUTTOM



Remove Control Y09



Door Bell

SIZE (MM) \ MODEL NO	SQ300	SQ400	SQ500	SQ600	SQ800	SQ1000	SQ1500
A (FULL LONG)	300	400	535	635	835	1035	1535
B (HOLE TO HOLE)	265	365	500	600	800	1000	1500
C	25	25	25	25	25	25	25
D	38	38	38	38	38	38	38
COLOR	SS/BLK	SS/BLK /MGP	SS/BLK /MGP	SS/BLK /MGP	SS/BLK /MGP	SS/BLK /MPG/PVD	SS/BLK /PVD

**H-TYPE PULL HANDLE**  
(SUITABLE FOR WOODEN,STEEL,ALUMINIUM, GLASS DOOR )

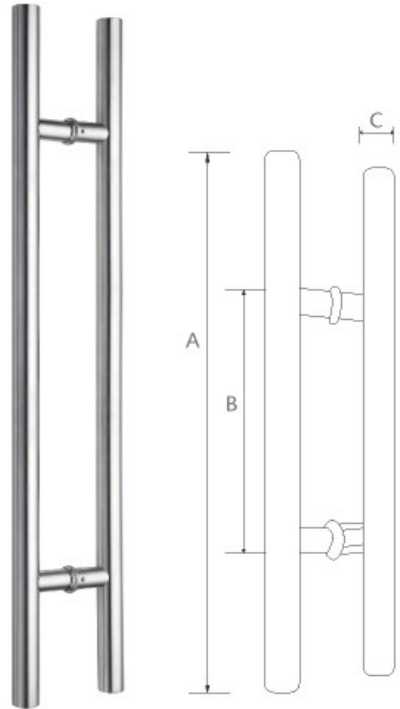

SIZE	200*32	450*32	600*32	1000*32	1500*32
A	200	450	600	1000	835
B	140	300	400	600	800
C	32	32	32	32	32
COLOR	SS	SS/BLK	SS	SS/PVD	SS

ROUND HANDLE

**SC-TYPE PULL HANDLE**  
(SUITABLE FOR WOODEN,STEEL,ALUMINIUM, GLASS DOOR )

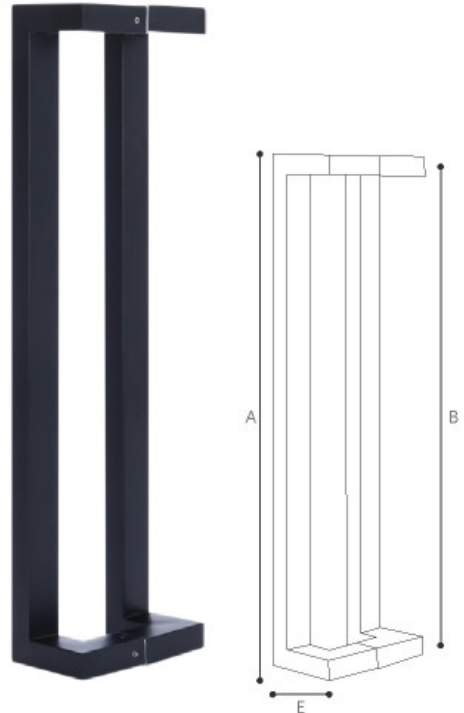

SIZE	SC600	SC1200
A FULL LONG	635	1235
B HOLE TO HOLE	600	1200
C		
D		
E	80	80
COLOR	SS/BLK/MAP/PVD	SS/BLK/MAP/PVD

**DOOR LOCK SERIES**

**PULL HANDLE**



Model No: K008 SN



Model No: K008 AB



Model No: K008 GP



Model No: K008 AC



SY259 SN



SY259 PVD



SY271 MAB

SY271 MAC

SY271 MAE

SY271 SN

SY271 GP

SY001 SN

SY001 MAB  
AVAILABLE : PVD



Model No: 8545 SS

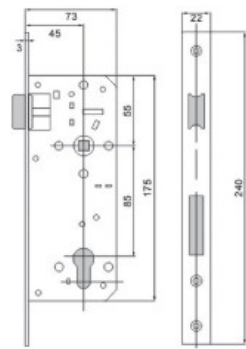

Model No: 8518 R SS  
AVAILABLE : GP BLK

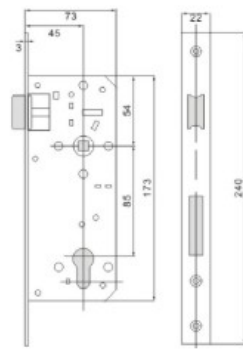

Model No: HK8545

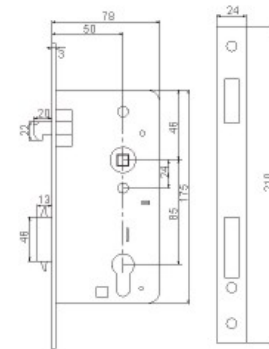

Model No: 8520

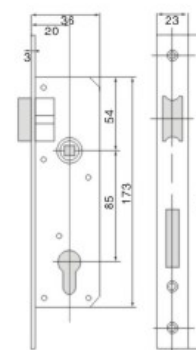

Model No: 8525

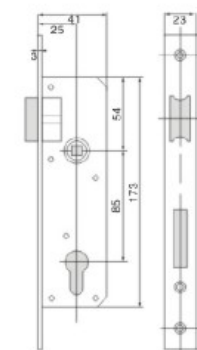

Model No: 8530

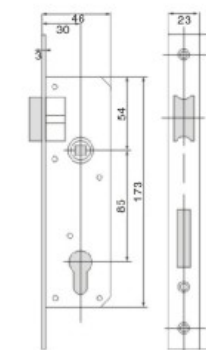

Model No: 8530R

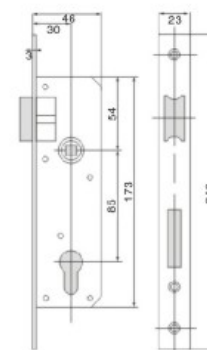

Model No: 8535

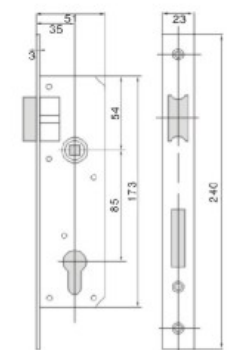

Model No: 8560 SS

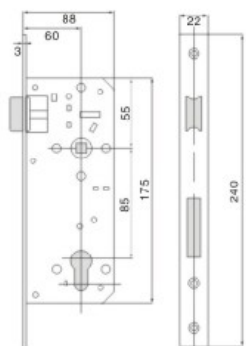

Model No: 7255 SS

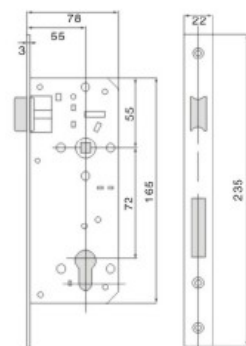

Model No: 8550 SS

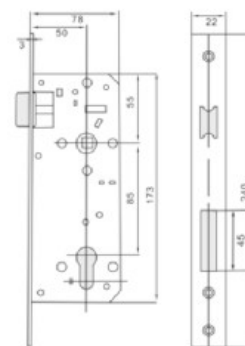

Model No: 8555 SS

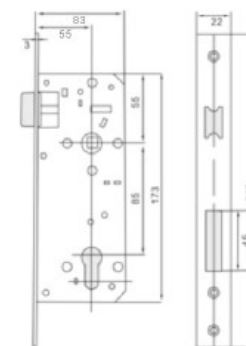

Model No: 8540

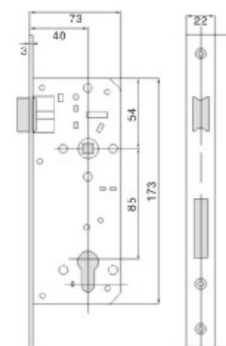

Model No: F55 SS

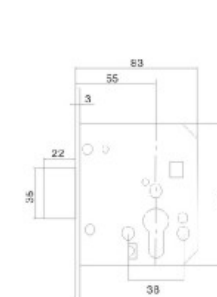

Model No: 7855

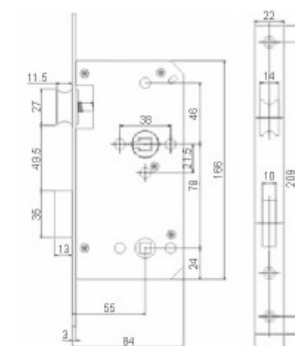

Model No: D58

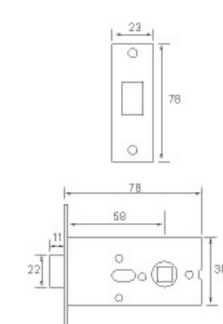

Model No: 8517-4R CP

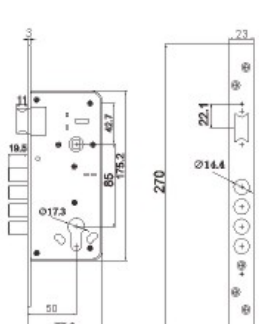

## Adjustable concealed hinge

## Adjustable concealed hinge

## DOOR LOCK SERIES

### HD001

#### FEATURES

- For wooden doors
- For flush doors
- Concealed installation
- Adjustable after installed
- Adjustments
- vertical  $\pm 3\text{mm}$ , horizontal  $+2\text{mm}$ ,  $-2\text{mm}$  and depth  $\pm 1\text{mm}$
- Opening angle:  $180^\circ$

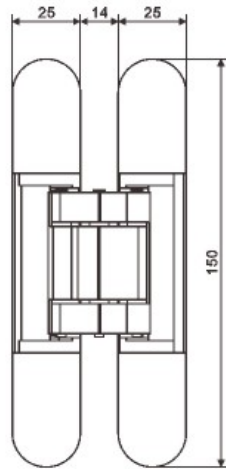

#### TECHNICAL DATA

Max door weight with 2 hinges	40kg
Min door thickness	35mm
Max door width	850mm
Slim design for thin door	21.5mm

#### MATERIALS

Zinc Alloy, Alum

#### FINISHES

Chrome, Nickle, Brass and Painting

#### INSTALLATION

Wood tapping screws, Iron screws optional

Note  
Finger protection due to small gap between door and frame

Application  
Completely concealed for flush door with wood steel or aluminum frame

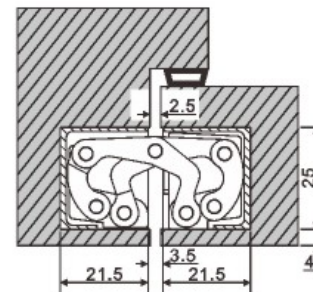

#### CUT OUT

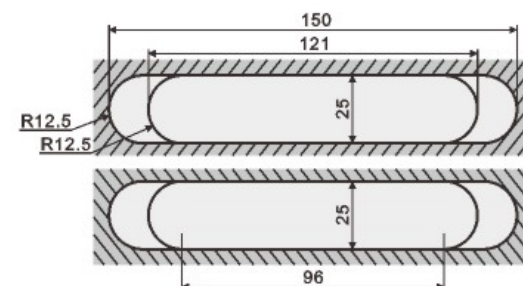
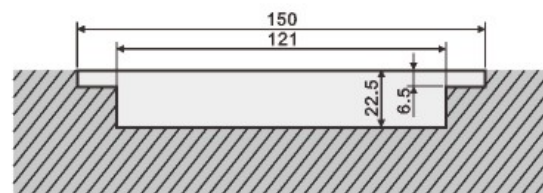

### HD002

#### FEATURES

- For wooden doors
- For flush doors
- Concealed installation
- Adjustable after installed
- Adjustments
- vertical  $\pm 3\text{mm}$ , horizontal  $+2\text{mm}$ ,  $-2\text{mm}$  and depth  $\pm 1\text{mm}$
- Opening angle:  $180^\circ$

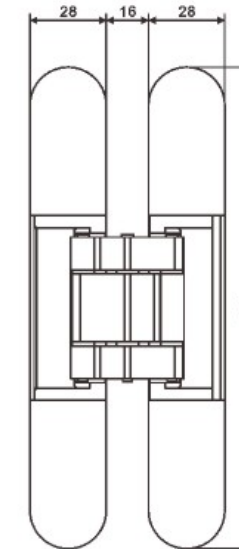

#### TECHNICAL DATA

Max door weight with 2 hinges	80kg
Min door thickness	40mm
Max door width	1000mm
Slim design for thin door	24.5mm

#### MATERIALS

Zinc Alloy, Alum

#### FINISHES

Chrome, Nickle, Brass and Painting

#### INSTALLATION

Wood tapping screws, Iron screws optional

Note  
Finger protection due to small gap between door and frame

Application  
Completely concealed for flush door with wood steel or aluminum frame

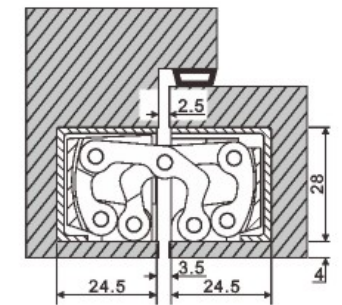

#### CUT OUT

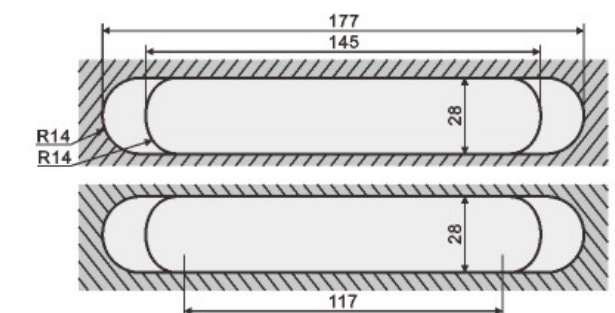
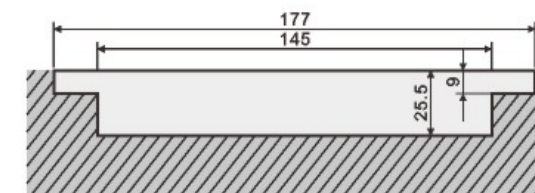



**HEAVY DUTY CONCEAL HINGES**

**DOOR LOCK SERIES**



**Model No: HD 004 SN**

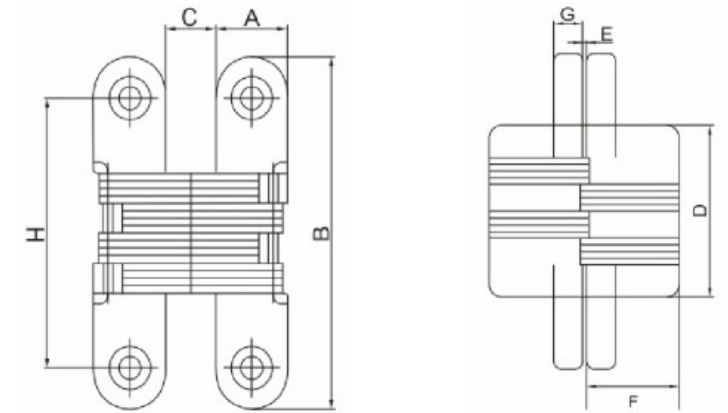

Dimension (mm)										DOOR THICKNESS	Bearing Weight kg/pcs	Each Weight g/pcs
A	B	C	D	E	F	G	H					
28	118	22	62	1.4	41	9.5	out hole 93	inter hole 87	35-50mm	40 kg	785 g	

**CLOSING FUNCTION HINGES**



**Model No: CLS4\*3\*3 BLK**



**Model No: CLS4\*3\*3 SS AVAILABLE GP COLOR**



**Model No: CLS4\*2.5 BT SS AVAILABLE GP COLOR**



**Model No: CLS4\*2.5 BT BLK**

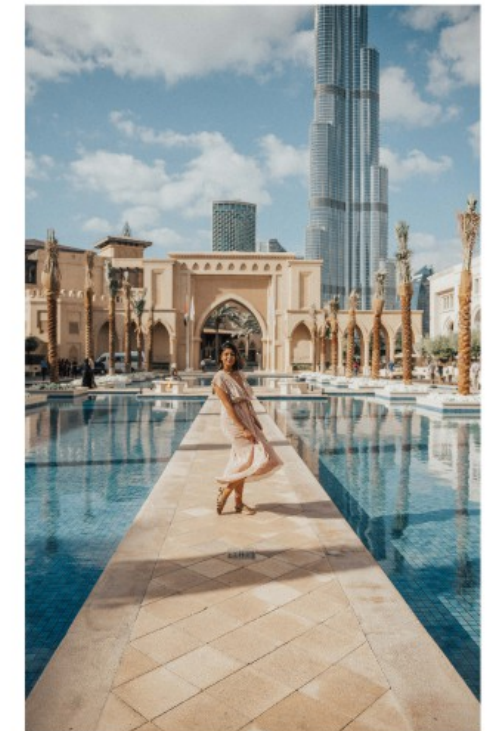

HEAVY DUTY DOOR HINGES



4\*3\*3 SS



4\*3\*3 BLACK



4\*3\*3 MAB



4\*3\*3 MATTE GP



4\*2.5 BT BLACK



4\*2.5 BT SS



6\*3.5\*3 SS



5\*3\*3 SS



5\*3.5\*3 SS

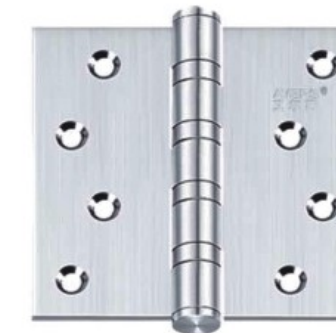

4\*4\*3 SS



4\*3.5\*3 SS

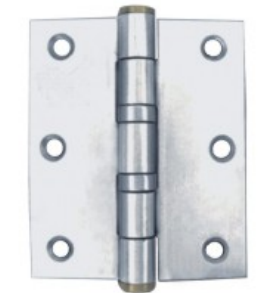

3\*2.5 SS



HEAVY DUTY DOOR HINGES

SPECIFICATION:

NAME	FLAT OPEN DOOR HINGES
SIZE:	4*3*3 SS (AXE 13.5MM)
MATERIAL:	STAINLESS STEEL 304 OR 201
MIN DOOR THICKNESS:	35MM
MAX DOOR WEIGHT:	100 KG/3 PCS
SUITABLE FOR:	ALL KINDS WOODEN GATE DOOR, WOODEN ROOM DOOR
QUALITY TEST:	FIRE-RATED: 90 MINUTES CE MARKING ORIGINAL BEARING (SWITCHING FLEXIBILITY, NO NOISE, LONG LIFE) SUCCESSFULLY PASS 200,000 OPEN/CLOSE TEST
GUARRANTY:	5 YEAR

EURO PROFILE CYLINDER

EURO PROFILE CYLINDER



60MM 2S (30MM+30MM)  
COLOR: SN GP



60MM 1S (30MM+30MM)  
COLOR: SN



60MM ZBK (30MM+30MM)  
COLOR: SN



E70MM 1S (35MM+35MM)  
COLOR: SN



80MM 2S (40MM+40MM)  
COLOR: SN GP AB BLK



80MM 1S (40MM+40MM)  
COLOR: SN



70MM 2S (35MM+35MM)  
COLOR: BLK



70MM 2S (35MM+35MM)  
COLOR: SN AB AC



70MM 2S (35MM+35MM)  
COLOR: GP



B70MM 2S (35MM+35MM)  
COLOR: SN(GP AVAILABLE)



B90MM 2S (45MM+45MM)  
COLOR: SN



B100MM 2S(50MM+50MM)  
COLOR: SN



70MM 1S (35MM+35MM)  
COLOR: SN (GP,AB,AC AVAILABLE)



70MM 1S (35MM+35MM)  
COLOR: BK (GP,AB,AC AVAILABLE)



70MM ZBK (35MM+35MM)  
COLOR: SN (GP,AB,AC AVAILABLE)



B110MM 2S (55MM+55MM)  
COLOR: SN(GP AVAILABLE)



B120MM (60MM+60MM)  
COLOR: SN

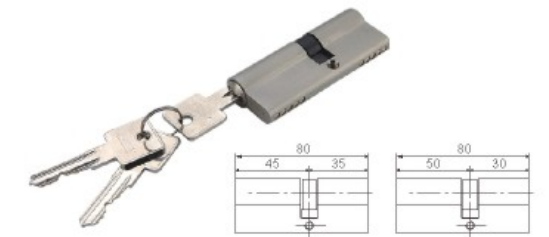

B80MM-UN(35MM+45MM)  
B80MM-UN(30MM+50MM)  
COLOR: SN



E70MM 2S (35MM+35MM)  
COLOR: SN (GP,AB,AC AVAILABLE)



UNION CYLINDER  
Material: Zinc alloy



B45MM  
COLOR: SN



B90MM-UN(30MM+60MM)  
COLOR: SN



B90MM-UN(35MM+55MM)  
COLOR: SN

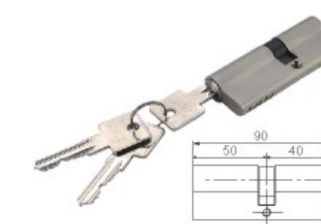

B90MM-UN(40MM+50MM)  
COLOR: SN



B100MM-UN(30MM+70MM)  
COLOR: SN

OVER HEAD DOOR CLOSER

ANTI-FIRE DOOR CLOSER:603

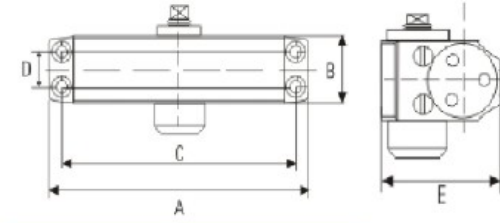

Product model	A	B	C	D	E
603 SN	186MM	45MM	168MM	19MM	68MM

Specifications and Features

Slim Desind

603 has a compact size with minimized projection allowing installation to door's adjacent return wall.

Full Rack And Pinion Construction

Heat-treated rack and pinion immersed in high grade oil for smooth action and minimum wear and tear

Selectable Power Size by Mounting position

MAX DOOR WIDTH (MM)	1050
MAX DOOR WEIGHT (KGS)	70
MAX OPENING ANGLE	180°

Non Handed

603 can be universally fitted on both left and right handed swing doors

Flexible Mounting Position

603 can be installed on both pull and push side of door and can be fitted on both door and frame

Adjustable Latching and Closing Speed

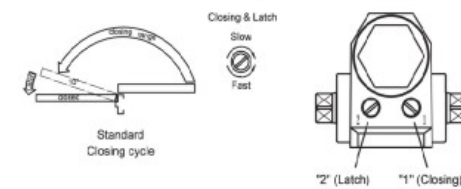

Finishes

in stock, available silver (sn),white,ab  
Finish: silver,golden,white,black

Material:

Aluminum Alloy Prssure Die-Cast

Application:

603 is an overhead door closer suitable for standard to medium weight doors for both interior or exterior application.

Standars And Certification:

Certificate Of Constancy Of Performance  
0359-CPR-00071-02

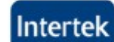

All test performed independently and certified by intertek Testing and Certification Ltd,at UK

CE Marking: CE Declaration of Conformity available on request.



Fire Safety: Successfully test on fire door assemblies according to EN 1154:1996/A1:2002/AC:2006

EN 1154:1996/A1:2002/AC:2006

product classification					
3	8	3	1 <sup>c</sup>	1	1

PANIC/EXIT DEVICES



PANIC BAR P500

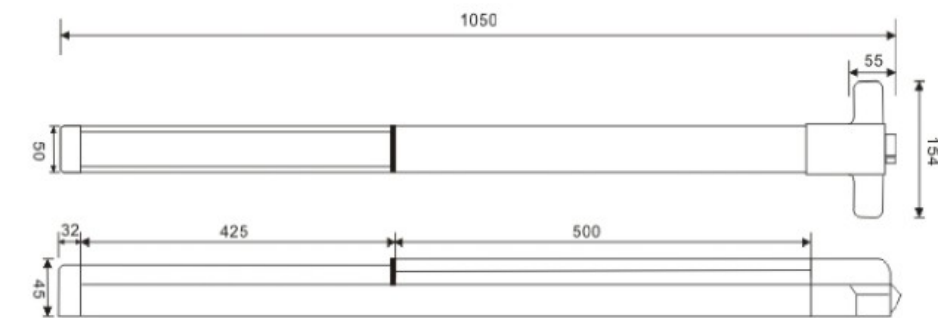

PANIC HANDLE P16



MATERIAL : ZINC ALLOY

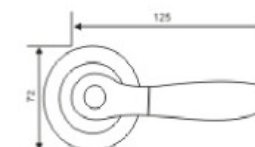

PANIC BAR P500

- Type: American Style, Push bar, Rim Type
- Material: Steel
- Length: 1050mm Standard,could be customized
- Non-handed, for left hand or right hand doors
- Chiese fire test 90 minutes (test in our factory)

CLASSIFICATION:

PANIC BAR P500: STELL, PAINTED, HALF LENGTH PUSH PAD





PADLOCK



DOOR RUBBER R



RIM LOCK 116



T1



225 W



224 W



WINDOW HANDLE



CLK2201



MICO 1862



1863



L003

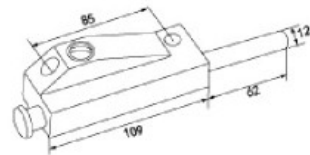
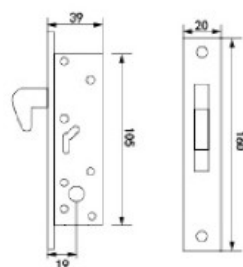
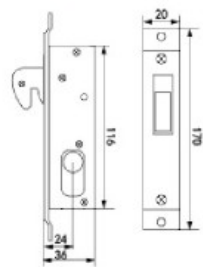

7058 SN



LH7059



CH7057

DOOR STOPPER

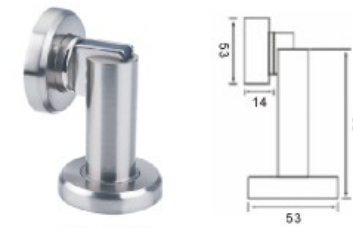

M118 SS



M113 SS

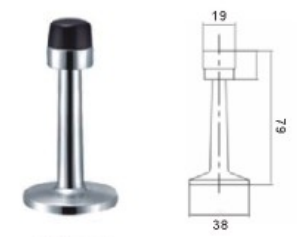

W008



M008



W010 SS BLK



TCF66



DS002

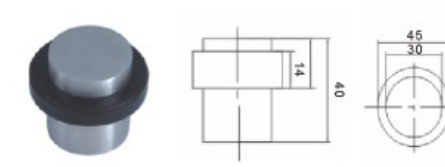

SP115 SS



HSP114  
SN GP AB AC BLK



DS1



DS2

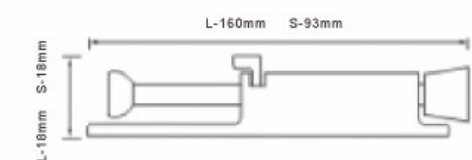
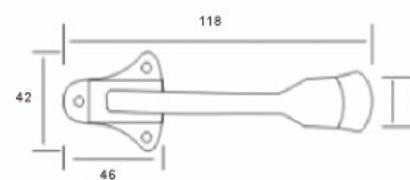

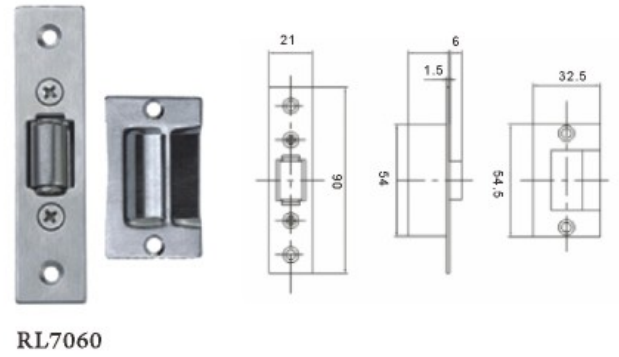

RL7060

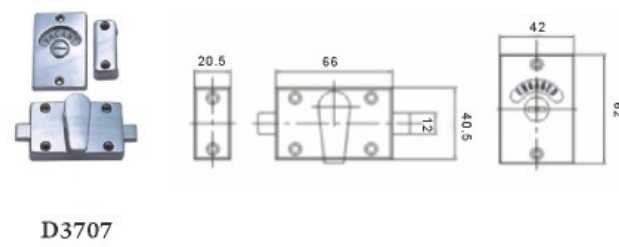

D3707

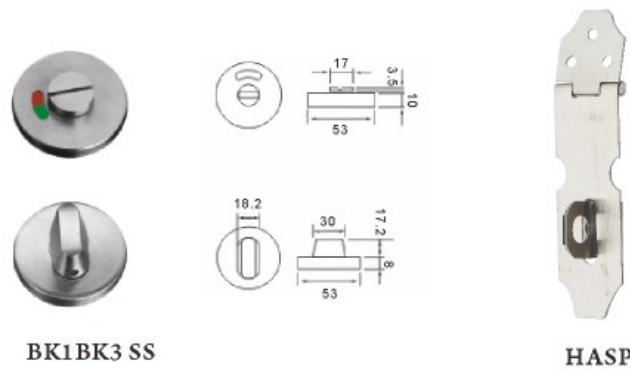

BK1BK3 SS

HASP

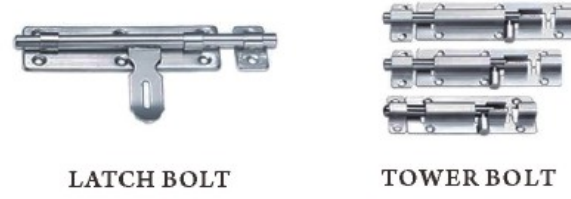

LATCH BOLT

TOWER BOLT



AUTO BOLT



FVA34-8



13822



103-16,20,25,30



B205  
COLOER SN GP BLK



B206 SN

CYLINDER ESCUTCHEN



E02 SS

E04 SS

E02-M SS

E04-M SS



R901 SN

R901 MAB

R901 MAE

R901 GP

R901 BLK

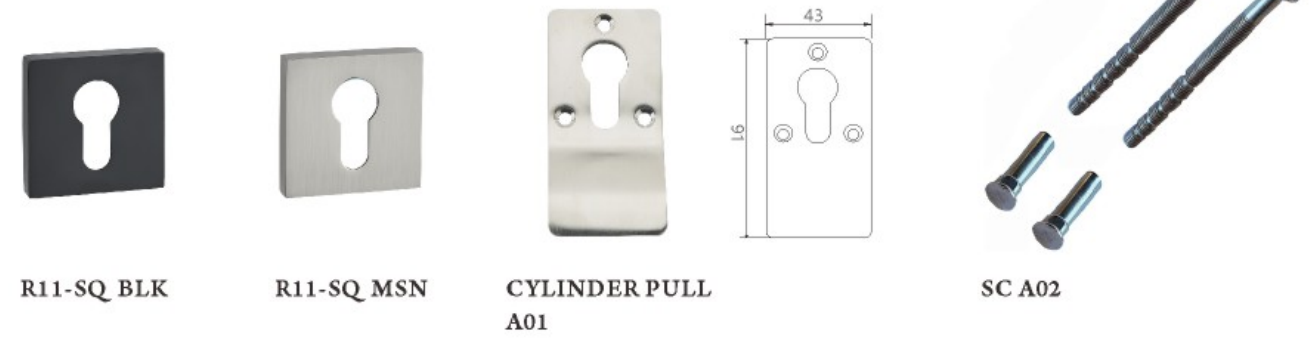

R11-SQ BLK

R11-SQ MSN

CYLINDER PULL  
A01

SC A02

